

DIN

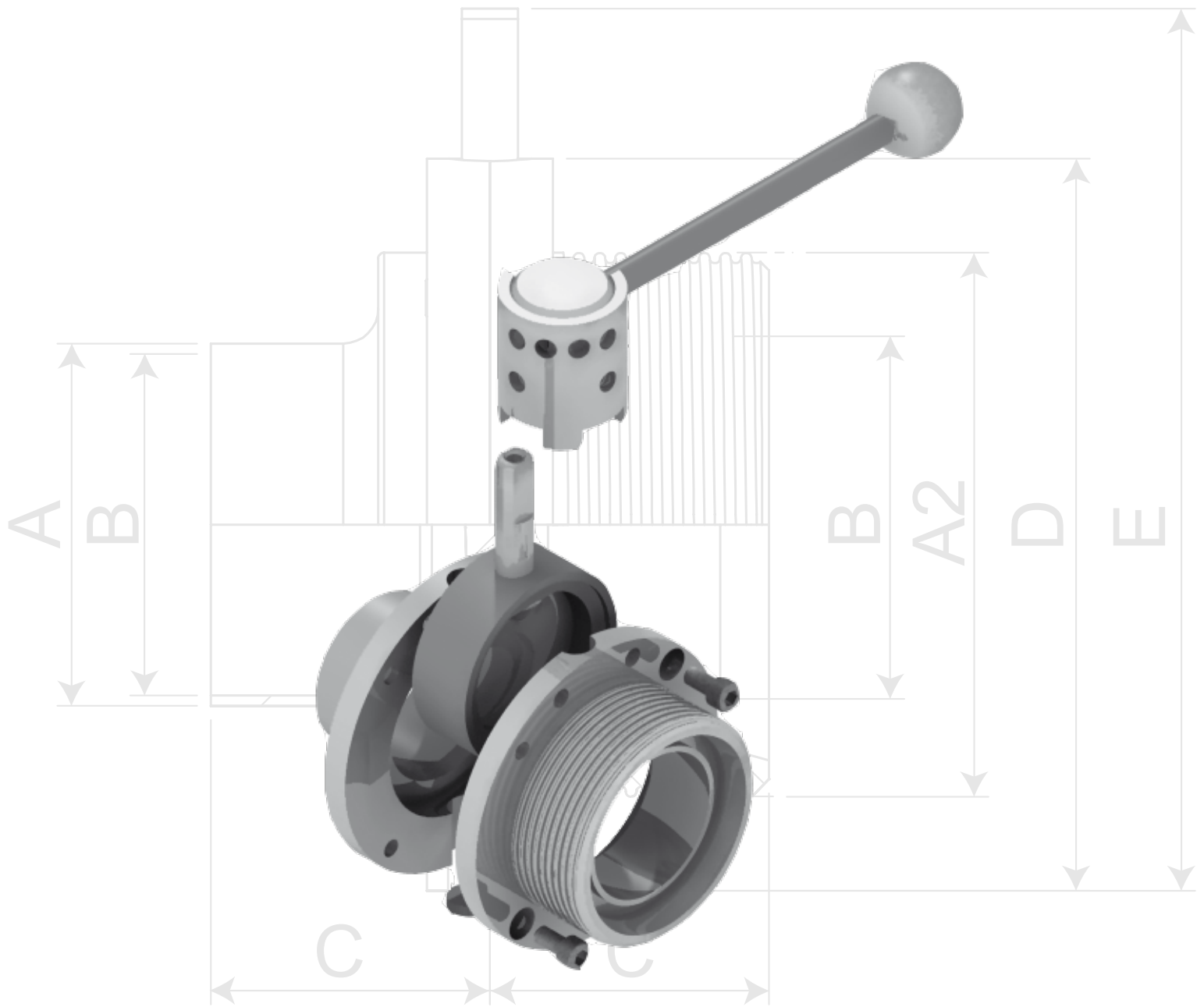

SODIME
PROCESS  SOLUTIONS

Norme DIN

Norma DIN

DIN standard

Стандарт DIN

Vanne papillon

Butterfly valve
 Valvula mariposa
 Затвор дисковый

54 - 55

Actionneur pneumatique et boîtier de contrôle

Pneumatic actuator and control box
 Actuador neumático cabeza de control
 Пневматический привод и блок управления

56 - 58

Pièce de rechange de vanne papillon

Spare part for butterfly valve
 Pieza de repuesto para válvula mariposa
 Запасные части для затвора дискового

59

Poignée de vanne papillon

Handle for butterfly valve
 Manilla para válvula mariposa
 Ручка для затвора дискового

60 - 63

Clapet anti-retour

Non-return valve
 Válvula de retención
 Обратный клапан

64

Indicateur de circulation

Sight glass
 Mirillas ventanillas
 Диоптр трубный

65

Filtre

Filter
 Filtro
 Фильтр

66

Raccord à souder et à dudgeonner

Welding and expanding union
 Union a soldar y a mandrinar
 Соединение резьбовое под сварку и развальцовку

67 - 73

Raccord clamp

Clamp union
 Union clamp
 Зажимное соединение

74 - 75

Coude, té et réduction

Elbow, tee and reducer
Codo, T y reducción
Отвод, тройник и переход

76 - 77

Collier de supportage

Pipe hanger
Soporte para tubo
Хомут для труб

78

Tube

Pipe
Tubo
Труба

79

Vanne papillon lisse/lisse (EPDM)
Válvula mariposa extremos soldables (EPDM)

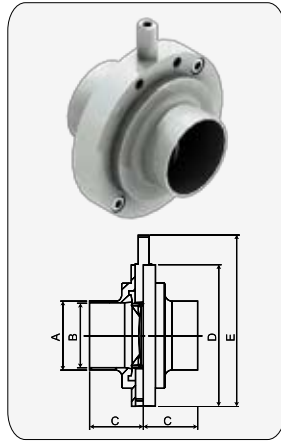

CODE	DN		A	B	C	D	E
VPLL 6L D JEP 28 VPLL 04 D JEP 28	25	316L 304	28.00	25.00	34.00	79.00	101.00
VPLL 6L D JEP 34 VPLL 04 D JEP 34	32	316L 304	34.00	31.00	38.00	85.00	107.00
VPLL 6L D JEP 40 VPLL 04 D JEP 40	40	316L 304	40.00	37.00	38.00	90.00	112.00
VPLL 6L D JEP 52 VPLL 04 D JEP 52	50	316L 304	52.00	49.00	40.00	105.00	127.00
VPLL 6L D JEP 70 VPLL 04 D JEP 70	65	316L 304	70.00	66.00	41.00	125.00	147.00
VPLL 6L D JEP 85 VPLL 04 D JEP 85	80	316L 304	85.00	81.00	42.00	137.00	159.00
VPLL 6L D JEP 104 VPLL 04 D JEP 104	100	316L 304	104.00	100.00	44.00	157.00	180.50

Joint FKM ou SILICONE sur demande / FKM or SILICON gaskets on request
Junta FKM o SILICONO a petición / Уплотнение ФKM и СИЛИКОН по запросу

Butterfly valve weld/weld ends (EPDM)
Затвор дисковый Сварка/Сварка (EPDM)

Vanne papillon lisse/filetée (EPDM)
Válvula mariposa soldar/ferrúla roscada (EPDM)

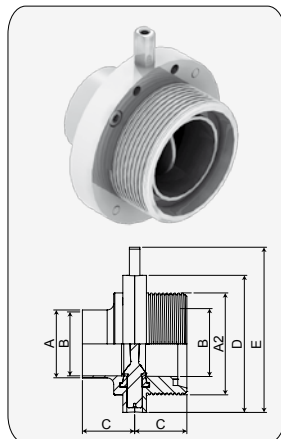

CODE	DN		A	A2	B	C	D	E
VPLF 6L D JEP 28 VPLF 04 D JEP 28	25	316L 304	28.00	52 x 1/6"	25.00	34.00	79.00	101.00
VPLF 6L D JEP 34 VPLF 04 D JEP 34	32	316L 304	34.00	58 x 1/6"	31.00	38.00	85.00	107.00
VPLF 6L D JEP 40 VPLF 04 D JEP 40	40	316L 304	40.00	65 x 1/6"	38.00	38.00	90.00	112.00
VPLF 6L D JEP 52 VPLF 04 D JEP 52	50	316L 304	52.00	78 x 1/6"	49.00	40.00	105.00	127.00
VPLF 6L D JEP 70 VPLF 04 D JEP 70	65	316L 304	70.00	95 x 1/6"	66.00	41.00	125.00	147.00
VPLF 6L D JEP 85 VPLF 04 D JEP 85	80	316L 304	85.00	110 x 1/4"	81.00	42.00	137.00	159.00
VPLF 6L D JEP 104 VPLF 04 D JEP 104	100	316L 304	104.00	130 x 1/4"	100.00	50.00	157.00	180.50

Joint FKM ou SILICONE sur demande / FKM or SILICON gaskets on request
Junta FKM o SILICONO a petición / Уплотнение ФKM и СИЛИКОН по запросу

Butterfly valve weld/male ends (EPDM)
Затвор дисковый Сварка/Резьба (EPDM)

Vanne papillon filetée/filetée (EPDM)
Válvula mariposa extremos ferrúlas roscadas (EPDM)

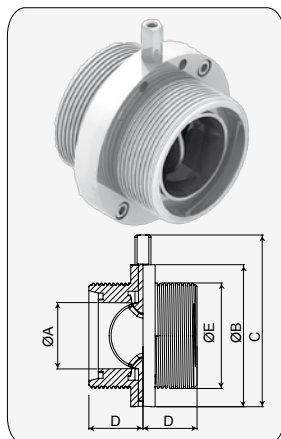

CODE	DN		A	B	C	D	E
VPFF 6L D JEP 28 VPFF 04 D JEP 28	25	316L 304	25.00	79.00	101.00	34.00	52 x 1/6"
VPFF 6L D JEP 34 VPFF 04 D JEP 34	32	316L 304	31.00	85.00	107.00	38.00	58 x 1/6"
VPFF 6L D JEP 40 VPFF 04 D JEP 40	40	316L 304	37.00	90.00	112.00	38.00	65 x 1/6"
VPFF 6L D JEP 52 VPFF 04 D JEP 52	50	316L 304	49.00	105.00	127.00	40.00	78 x 1/6"
VPFF 6L D JEP 70 VPFF 04 D JEP 70	65	316L 304	66.00	125.00	147.00	41.00	95 x 1/6"
VPFF 6L D JEP 85 VPFF 04 D JEP 85	80	316L 304	81.00	137.00	159.00	42.00	110 x 1/4"
VPFF 6L D JEP 104 VPFF 04 D JEP 104	100	316L 304	100.00	157.00	180.50	50.00	130 x 1/4"

Joint FKM ou SILICONE sur demande / FKM or SILICON gaskets on request
Junta FKM o SILICONO a petición / Уплотнение ФKM и СИЛИКОН по запросу

Butterfly valve male/male ends (EPDM)
Затвор дисковый Резьба/Резьба (EPDM)

Vanne papillon lisse/lisse grand diamètre (EPDM)

Válvula mariposa extremos soldables para gran diam. (EPDM)

Butterfly valve weld/weld ends large size (EPDM)

Затвор дисковый Сварка/Сварка больших диаметров

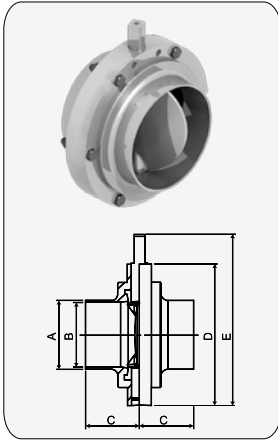

CODE	DN		A	B	C	D	E
RPLL 6L D JEP 125	125	316L	129.00	125.00	57.00	200.00	220.00
RPLL 04 D JEP 125		304					
RPLL 6L D JEP 154	150	316L	154.00	150.00	62.00	230.00	250.00
RPLL 04 D JEP 154		304					

Joint FKM ou SILICONE sur demande / FKM or SILICON gaskets on request
Junta FKM o SILICONO a petición / Уплотнение ФKM и СИЛИКОН по запросу

Vanne papillon entre-bridés lisse/lisse (EPDM)

Válvula mariposa entre bridas extremos soldables (EPDM)

Intermediate-flanged butterfly valve (EPDM)

Затвор дисковый межфланцевый Сварка/Сварка (EPDM)

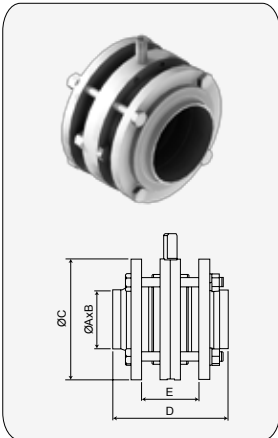

CODE	DN		A	B	C	D	E
VPLL EB 6L JEP D 28	25	316L	28.00	25.00	79.00	100.00	50.00
VPLL EB 04 JEP D 28		304					
VPLL EB 6L JEP D 34	32	316L	34.00	31.00	85.00	100.00	50.00
VPLL EB 04 JEP D 34		304					
VPLL EB 6L JEP D 40	40	316L	40.00	37.00	90.00	100.00	50.00
VPLL EB 04 JEP D 40		304					
VPLL EB 6L JEP D 52	50	316L	52.00	49.00	105.00	100.00	50.00
VPLL EB 04 JEP D 52		304					
VPLL EB 6L JEP D 70	65	316L	70.00	66.00	125.00	100.00	50.00
VPLL EB 04 JEP D 70		304					
VPLL EB 6L JEP D 85	80	316L	85.00	81.00	137.00	100.00	50.00
VPLL EB 04 JEP D 85		304					
VPLL EB 6L JEP D 104	100	316L	104.00	100.00	157.00	100.00	50.00
VPLL EB 04 JEP D 104		304					

Joint FKM ou SILICONE sur demande / FKM or SILICON gaskets on request
Junta FKM o SILICONO a petición / Уплотнение ФKM и СИЛИКОН по запросу

Vanne papillon lisse/lisse DIN 11850-2 (EPDM)

Válvula mariposa extremos soldables (EPDM) DIN 11850-2

Butterfly valve weld/weld ends DIN 11850-2 (EPDM)

Затвор дисковый Сварка/Сварка DIN 11850-2 (EPDM)

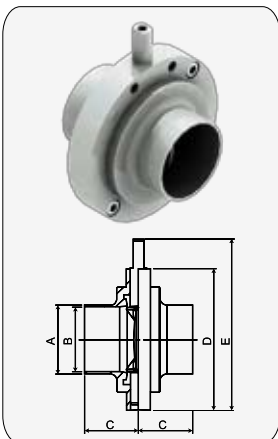

CODE	DN		A	B	C	D	E
VPLL 6L D JEP 29	25	316L	29.00	26.00	34.00	79.00	101.00
VPLL 04 D JEP 29		304					
VPLL 6L D JEP 35	32	316L	35.00	32.00	38.00	85.00	107.00
VPLL 04 D JEP 35		304					
VPLL 6L D JEP 41	40	316L	41.00	38.00	38.00	90.00	112.00
VPLL 04 D JEP 41		304					
VPLL 6L D JEP 53	50	316L	53.00	50.00	40.00	105.00	127.00
VPLL 04 D JEP 53		304					

Joint FKM ou SILICONE sur demande / FKM or SILICON gaskets on request
Junta FKM o SILICONO a petición / Уплотнение ФKM и СИЛИКОН по запросу



Vérin pneumatique simple effet

Actuador neumático simple efecto



Air / spring pneumatic actuator

Пневматический привод Воздух / Пружина

TYPE	CODE	DN
K3	VVSE K 3	25-76

Double effet sur demande / Air - air on request
doble efecto a petición / Воздух/Воздух по запросу

Vérin pneumatique simple effet

Actuador neumático simple efecto

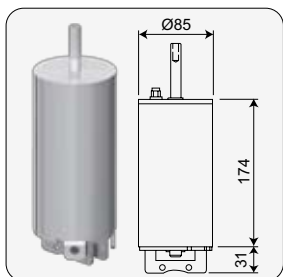

Air / spring pneumatic actuator

Пневматический привод Воздух / Пружина

TYPE	CODE	DN
K1111	VVSE K 1111	25-76

Double effet sur demande / Air - air on request
doble efecto a petición / Воздух/Воздух по запросу

Vérin pneumatique simple effet

Actuador neumático simple efecto

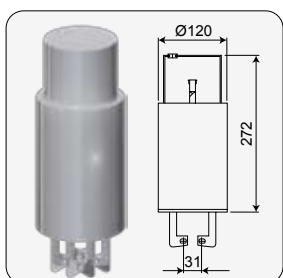

Air / spring pneumatic actuator

Пневматический привод Воздух / Пружина

TYPE	CODE	DN
K 104	VVSE K 104	85-104

Double effet sur demande / Air - air on request
doble efecto a petición / Воздух/Воздух по запросу

Vérin pneumatique simple effet

Actuador neumático simple efecto



Air / spring pneumatic actuator

Пневматический привод Воздух / Пружина

TYPE	CODE	DN
K311	VVSE K 311	25-76

Double effet sur demande / Air - air on request
doble efecto a petición / Воздух/Воздух по запросу

Vérin pneumatique simple effet
Actuador neumático simple efecto

Air / spring pneumatic actuator
Пневматический привод Воздух / Пружина



TYPE	CODE	DN
K301	VVSE K 301	25-76

Double effet sur demande / Air - air on request
doble efecto a petición / Воздух/Воздух по запросу



Vérin pneumatique simple effet
Actuador neumático simple efecto

Air / spring pneumatic actuator
Пневматический привод Воздух / Пружина

TYPE	CODE	DN
K125 / 154	VVSE K 125/154	125-154

Double effet sur demande / Air - air on request
doble efecto a petición / Воздух/Воздух по запросу

Boîtier de contrôle inox

Cabeza de control

Stainless steel control unit

Блок управления

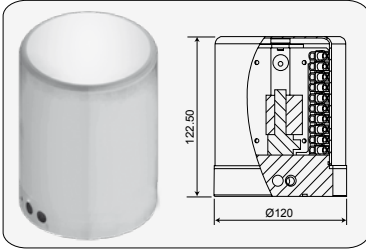

CODE	SS
BU K 1111	304

Boîtier de contrôle interface ASI II

Cabeza de control ASI II

ASI II Control Unit

Блок управления ASI II

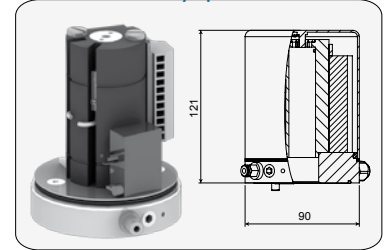

CODE	SS
BUE ASI K 1111	304

**Boîtier de contrôle simple effet
Control box air / spring**

Cabeza de control simple efecto

Блок управления Воздух / Пружина



**Boîtier de contrôle double effet
Control box air / air**

Cabeza de control doble efecto

Блок управления Воздух / Воздух



**Boîtier de contrôle ASI II
Control box ASI II**

Cabeza de control ASI II

Блок управления ASI II

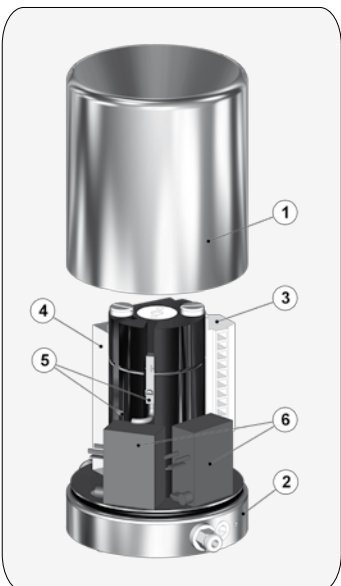

N°	Designation / Description / Designación / Название
1	Capot inox / Stainless steel cover / Tapa Inox / Крышка из нержавеющей стали
2	Embase inox / Stainless steel base / Embase Inox / Основа из нержавеющей стали
3	Barette de connection / Electrical connector / Conector eléctrico / Электро-соединительная планка
4	Carte ASI II / ASI II card / Tarjeta Asi II / Карта Asi II
5	Détecteurs de proximité / Proximity switch / Detector de proximidad / Детектор близости
6	Electrovanne / Electro-valve / Electroválvula / Электрозатвор

Papillon

Mariposa

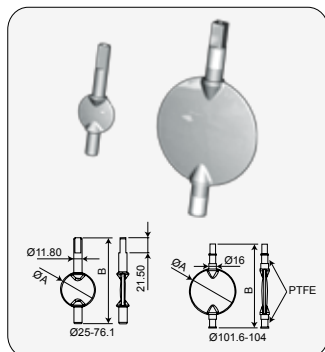

Spindle

Заслонка дисковая

CODE	DN		A	B
PAPE 6L 25 28	25	316L	22.50	96.50
PAPE 04 25 28		304		
PAPE 6L 34 38	32	316L	36.00	103.00
PAPE 04 34 38		304		
PAPE 6L 40 43	40	316L	36.00	103.00
PAPE 04 40 43		304		
PAPE 6L 51 52	50	316L	50.00	123.00
PAPE 04 51 52		304		
PAPE 6L 70 76	65	316L	70.50	147.00
PAPE 04 70 76		304		
PAPE 6L 83 85	80	316L	79.50	159.00
PAPE 04 83 85		304		
PAPE 6L 104	100	316L	100.00	180.60
PAPE 04 104		304		

Joint de vanne papillon

Junta de válvula mariposa

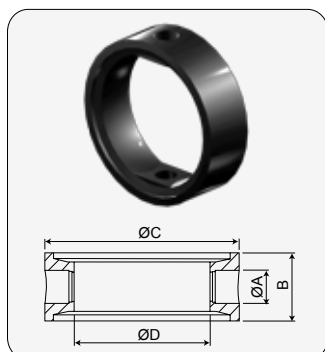

Seal for butterfly valve

Уплотнение для затвора дискового

CODE	DN		A	B	C	D
JVEU EP 25 28	25	EPDM	10.80	23.00	38.50	21.50
JVEU VI 25 28		FKM				
JVEU SI 25 28		SILICON				
JVEU EP 34 38	32	EPDM	10.80	23.00	51.50	34.50
JVEU VI 34 38		FKM				
JVEU SI 34 38		SILICON				
JVEU EP 40 43	40	EPDM	10.80	23.00	54.50	37.50
JVEU VI 40 43		FKM				
JVEU SI 40 43		SILICON				
JVEU EP 51 52	50	EPDM	10.80	23.00	65.50	48.50
JVEU VI 51 52		FKM				
JVEU SI 51 52		SILICON				
JVEU EP 70 76	65	EPDM	10.80	25.00	89.00	70.00
JVEU VI 70 76		FKM				
JVEU SI 70 76		SILICON				
JVEU EP 83 85	80	EPDM	15.20	29.00	99.50	79.00
JVEU VI 83 85		FKM				
JVEU SI 83 85		SILICON				
JVEU EP 1016 104	100	EPDM	15.20	29.00	121.00	99.00
JVEU VI 1016 104		FKM				
JVEU SI 1016 104		SILICON				

Joint de vanne papillon

Junta de válvula mariposa



Seal for butterfly valve

Уплотнение для затвора дискового

CODE	DN	
JVEU EP 125	125	EPDM
JVEU EP 154	154	EPDM

Poignée de vanne papillon K1

Manilla para válvula mariposa K1

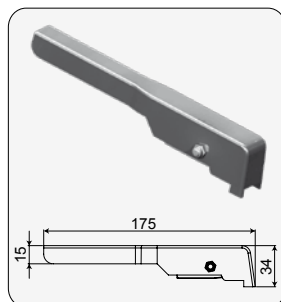

Handle for butterfly valve K1

Ручка для затвора дискового K1

CODE		DN
PEVP K 1	304	25-76

Poignée de vanne papillon K10 plastique

Manilla para válvula mariposa K10 plástica

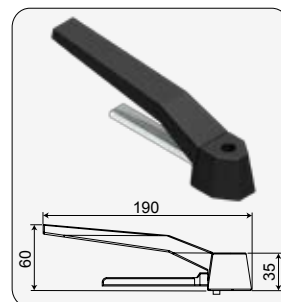

Handle for butterfly valve K10 plastic

Ручка для затвора дискового K10 пластмассовая

CODE		DN
PEVP K 10	PLAST.	25-76

Poignée de vanne papillon K20 multiposition

Manilla para válvula mariposa K20 multi-posición

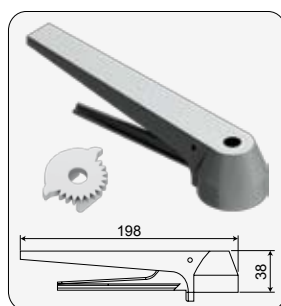

Multiposition handle for butterfly valve K20

Ручка для затвора дискового K20 многопозиционная

CODE		DN
PEVP K 20	304	25-76

Poignée de vanne papillon K204 multiposition

Manilla para válvula mariposa K204 multi-posición

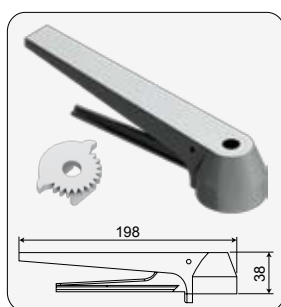

Multiposition handle for butterfly valve K204

Ручка для затвора дискового K204 многопозиционная

CODE		DN
PEVP K 204	304	85-104

Poignée de vanne papillon K20 plastique multiposition

Manilla para válvula mariposa K20 plástica multi-posición

Multiposition handle for butterfly valve K20 plastic

Ручка для затвора дискового K20 пластмассовая многопозиционная



CODE		DN
PEVP K 20 PL	PLAST.	25-76

Poignée de vanne papillon K41

Manilla para válvula mariposa K41

Handle for butterfly valve K41

Ручка для затвора дискового K41

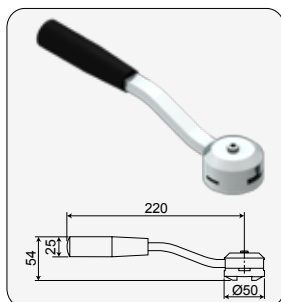

CODE		DN
PEVP K 41	304	25-76

Poignée de vanne papillon K104

Manilla para válvula mariposa K104

Handle for butterfly valve K104

Ручка для затвора дискового K104

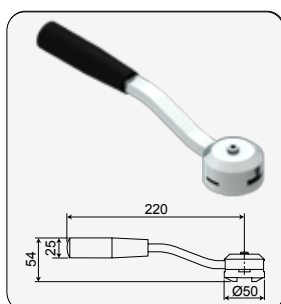

CODE		DN
PEVP K 104	304	85-104

Poignée de vanne papillon K33

Manilla para válvula mariposa K33

Handle for butterfly valve K33

Ручка для затвора дискового K33

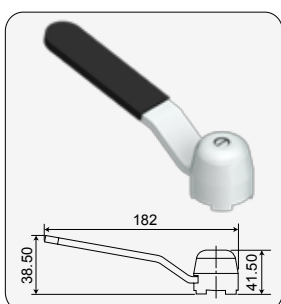

CODE		DN
PEVP K 33	304	25-76

Poignée de vanne papillon K34

Manilla para válvula mariposa K34

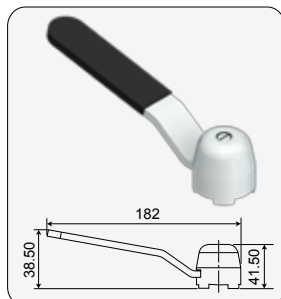

Handle for butterfly valve K34

Ручка для затвора дискового K34

CODE		DN
PEVP K 34	304	85-104

Poignée de vanne papillon K5 multiposition

Manilla para válvula mariposa K5 multi-posición

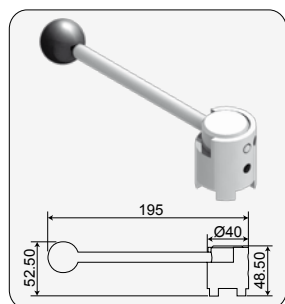

Multiposition handle for butterfly valve K5

Ручка для затвора дискового K5 многопозиционная

CODE		DN
PEVP K 5	304	25-76

Poignée de vanne papillon K54 multiposition

Manilla para válvula mariposa K54 multi-posición

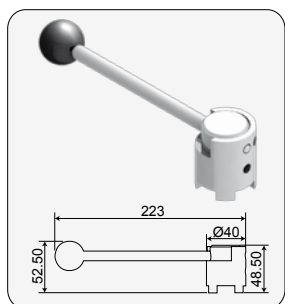

Multiposition handle for butterfly valve K54

Ручка для затвора дискового K54 многопозиционная

CODE		DN
PEVP K 54	304	85-104

Poignée de vanne papillon K125/154

Manilla para válvula mariposa K125/154



Handle for butterfly valve K125/154

Ручка для затвора дискового K125/154 многопозиционная

CODE		DN
PEVP K 125/154	304	125-154

Réglage micrométrique inox

Arreglo micrométrico

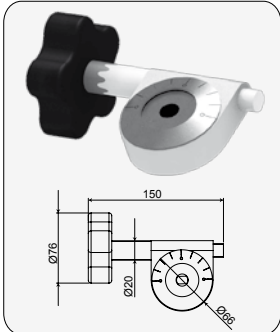

Micrometric handle

Микрометрическая регулировка

CODE		DN	
REMI K 1	304	25-76	
REMI K 104	304	85-104	

Kit de montage de détecteur crayon M18/M12 sur vanne manuelle

Montaje de un detector lápiz M18/M12 sobre una válvula manual

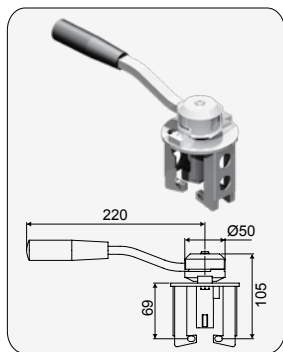

Mounting bracket for M18/M12 detector on manual valve

Приставка для детектора M18/M12 на ручной затвор

CODE		DN	
KVPM K1	304	25-76	
KVPM K104	304	85-104	

Clapet anti-retour lisse/lisse (EPDM)

Válvula de retención extremos soldables (EPDM)

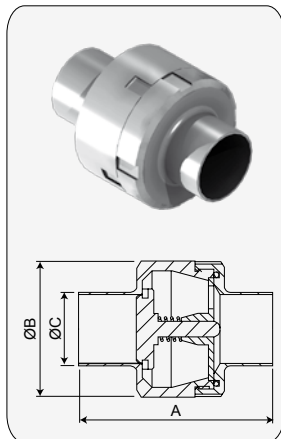

Non-Return valve weld/weld ends (EPDM)

Обратный клапан Сварка/Сварка (EPDM)

CODE	DN		A	B	C
CLBL 6L JEP D 28	25	316L	89.00	45.00	28.00
CLBL 6L JEP D 34	32	316L	101.00	70.00	34.00
CLBL 6L JEP D 40	40	316L	101.00	70.00	40.00
CLBL 6L JEP D 52	50	316L	108.00	83.00	52.00
CLBL 6L JEP D 70	65	316L	124.00	98.00	70.00
CLBL 6L JEP D 85	80	316L	138.00	106.00	85.00

Clapet anti-retour lisse/lisse DIN 11850-2 (EPDM)

Válvula de retención extremos soldables DIN 11850-2 (EPDM)

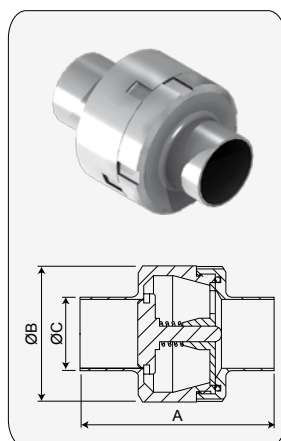

Non-Return valve weld/weld ends DIN 11850-2 (EPDM)

Обратный клапан Сварка/Сварка (EPDM)

CODE	DN		A	B	C
CLBL 6L JEP D 29	25	316L	89.00	45.00	29.00
CLBL 6L JEP D 35	32	316L	101.00	70.00	35.00
CLBL 6L JEP D 41	40	316L	101.00	70.00	41.00
CLBL 6L JEP D 53	50	316L	108.00	83.00	53.00

Indicateurs de circulation

Mirillas

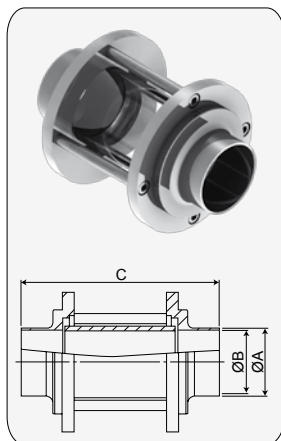

CODE	DN		A	B	C
IDS 6L D 28	25	316L	28.00	25.00	138.00
IDS 6L D 34	32	316L	34.00	31.00	146.00
IDS 6L D 40	40	316L	40.00	37.00	146.00
IDS 6L D 52	50	316L	52.00	49.00	150.00
IDS 6L D 70	65	316L	70.00	66.00	150.00
IDS 6L D 85	80	316L	85.00	81.00	152.00

Sight glass

Диоптр трубный

Indicateurs de circulation DIN 11850-2

Mirillas DIN 11850-2

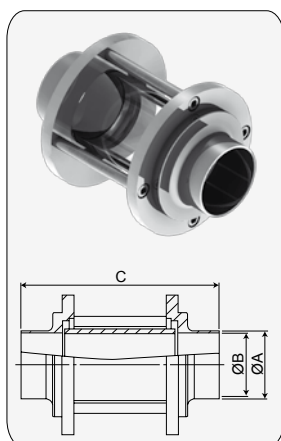

CODE	DN		A	B	C
IDS 6L D 29	25	316L	29.00	26.00	138.00
IDS 6L D 35	32	316L	35.00	32.00	146.00
IDS 6L D 41	40	316L	41.00	38.00	146.00
IDS 6L D 53	50	316L	53.00	50.00	150.00

Sight glass DIN 11850-2

Диоптр трубный DIN 11850-2

Grille d'indicateur inox

Protección inox para mirillas

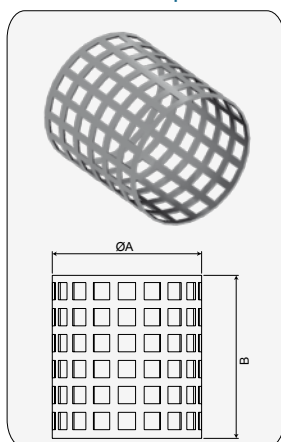

CODE	DN		A	B
GIDS 4L D 28	25	304	47.00	75.00
GIDS 4L D 34	32	304	55.00	75.00
GIDS 4L D 40	40	304	55.00	75.00
GIDS 4L D 52	50	304	69.00	75.00
GIDS 4L D 70	65	304	79.00	75.00
GIDS 4L D 85	80	304	93.00	75.00

Stainless steel protection for sight glass

Защита стекла трубного диоптра

Filtre équerre type SO

Filtro angular tipo SO

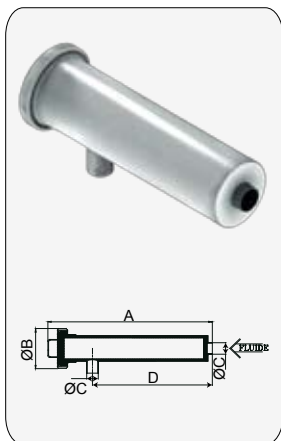

Angle filter type SO

Фильтр угловой тип SO

CODE	DN		A	B	C	D
FEBL SO 6L D 28	25	316L	455.00	148.00	28.00	300.00
FEBL SO 6L D 34	32	316L	455.00	148.00	34.00	300.00
FEBL SO 6L D 40	40	316L	455.00	148.00	40.00	300.00
FEBL SO 6L D 52	50	316L	455.00	148.00	52.00	300.00
FEBL SO 6L D 70	65	316L	493.00	178.00	70.00	340.00
FEBL SO 6L D 85	80	316L	493.00	178.00	85.00	340.00

Filtre équerre type R

Filtro angular tipo R

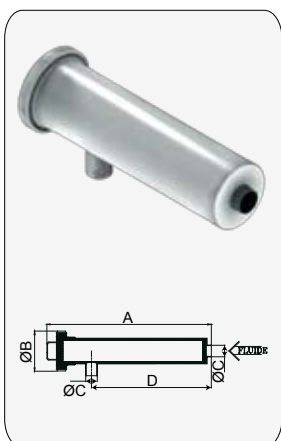

Angle filter type R

Фильтр угловой тип R

CODE	DN		A	B	C	D
FEBL R 6L D 28	25	316L	355.00	112.00	28.00	214.00
FEBL R 6L D 34	32	316L	355.00	112.00	34.00	214.00
FEBL R 6L D 52	50	316L	355.00	112.00	52.00	214.00
FEBL R 6L D 70	65	316L	389.00	148.00	70.00	242.00
FEBL R 6L D 85	80	316L	394.00	148.00	85.00	242.00

Raccord complet à souder joint BUNA DIN 11850-1

Unión a soldar DIN 11850-1 (junta BUNA)

Welding union BUNA gasket DIN 11850-1

Соединение резьбовое DIN 11850-1 с уплотнением BUNA

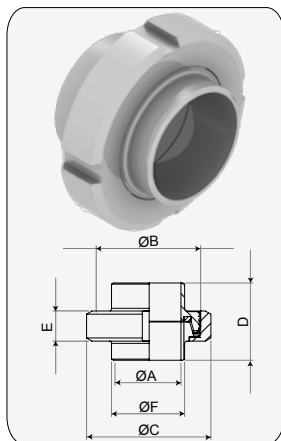

CODE	DN		A	B	C	D	E	F
RAS 6L D JBU 28	25	316L	25.00	52*1/6"	63.00	52.00	21.00	31.00
RAS 04 D JBU 28		304						
RAS 6L D JBU 34	32	316L	31.00	58*1/6"	70.00	53.00	21.00	37.00
RAS 04 D JBU 34		304						
RAS 6L D JBU 40	40	316L	37.00	65*1/6"	78.00	60.00	21.00	43.00
RAS 04 D JBU 40		304						
RAS 6L D JBU 52	50	316L	49.00	78*1/6"	92.00	64.00	22.00	55.00
RAS 04 D JBU 52		304						
RAS 6L D JBU 70	65	316L	66.00	95*1/6"	112.00	73.00	25.00	72.00
RAS 04 D JBU 70		304						
RAS 6L D JBU 85	80	316L	81.00	110*1/4"	127.00	76.00	30.00	87.00
RAS 04 D JBU 85		304						
RAS 6L D JBU 104	100	316L	100.00	130*1/4"	148.00	99.00	31.00	106.00
RAS 04 D JBU 104		304						
RAS 6L D JBU 125	125	316L	125.00	160*1/4"	178.00	81.00	35.00	132.00
RAS 04 D JBU 125		304						
RAS 6L D JBU 154	150	316L	150.00	190*1/4"	210.00	88.00	40.00	157.00
RAS 04 D JBU 154		304						

Raccord complet à souder joint BUNA DIN 11850-2

Unión a soldar DIN 11850-2 (junta BUNA)

Welding union BUNA gasket DIN 11850-2

Соединение резьбовое DIN 11850-2 с уплотнением BUNA

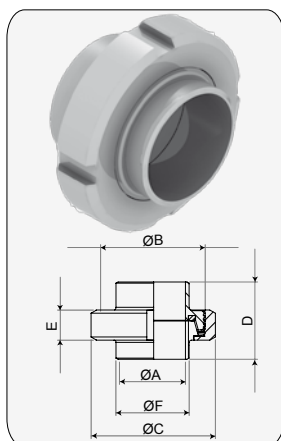

CODE	DN		A	B	C	D	E	F
RAS 6L D JBU 29	25	316L	26.00	52*1/6"	63.00	52.00	21.00	29.00
RAS 04 D JBU 29		304						
RAS 6L D JBU 35	32	316L	32.00	58*1/6"	70.00	53.00	21.00	35.00
RAS 04 D JBU 35		304						
RAS 6L D JBU 41	40	316L	38.00	65*1/6"	78.00	60.00	21.00	41.00
RAS 04 D JBU 41		304						
RAS 6L D JBU 53	50	316L	50.00	78*1/6"	92.00	64.00	22.00	53.00
RAS 04 D JBU 53		304						

Pièce filetée à souder DIN 11850-1
Ferrúla roscada a soldar DIN 11850-1

Welding male DIN 11850-1
Штуцер резьбовой DIN 11850-1

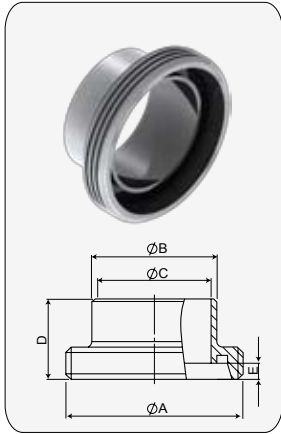

CODE	DN		A	B	C	D	E
PFAS 6L D 12 PFAS 04 D 12	12	316L 304	RD28 x 1/8"	15.00	10.00	21.00	4.00
PFAS 6L D 18 PFAS 04 D 18	15	316L 304	RD34 x 1/8"	21.00	16.00	21.00	4.00
PFAS 6L D 22 PFAS 04 D 22	20	316L 304	RD44 x 1/6"	25.00	20.00	24.00	6.00
PFAS 6L D 28 PFAS 04 D 28	25	316L 304	RD52 x 1/6"	31.00	26.00	29.00	7.00
PFAS 6L D 34 PFAS 04 D 34	32	316L 304	RD58 x 1/6"	37.00	32.00	32.00	7.00
PFAS 6L D 40 PFAS 04 D 40	40	316L 304	RD65 x 1/6"	43.00	38.00	33.00	7.00
PFAS 6L D 52 PFAS 04 D 52	50	316L 304	RD78 x 1/6"	55.00	50.00	35.00	7.00
PFAS 6L D 70 PFAS 04 D 70	65	316L 304	RD95 x 1/6"	72.00	66.00	40.00	8.00
PFAS 6L D 85 PFAS 04 D 85	80	316L 304	RD110 x 1/4"	87.00	81.00	45.00	8.00
PFAS 6L D 1016 PFAS 04 D 1016	100	316L 304	RD130 x 1/4"	104.00	99.00	54.00	10.00
PFAS 6L D 104 PFAS 04 D 104	100	316L 304	RD130 x 1/4"	106.00	100.00	54.00	10.00
PFAS 6L D 125 PFAS 04 D 125	125	316L 304	RD160 x 1/4"	132.00	125.00	46.00	12.00
PFAS 6L D 154 PFAS 04 D 154	150	316L 304	RD190 x 1/4"	157.00	150.00	50.00	13.00

Pièce lisse à souder DIN 11850-1
Ferrúla lisa a soldar DIN 11850-1

Welding liner DIN 11850-1
Штуцер конический DIN 11850-1

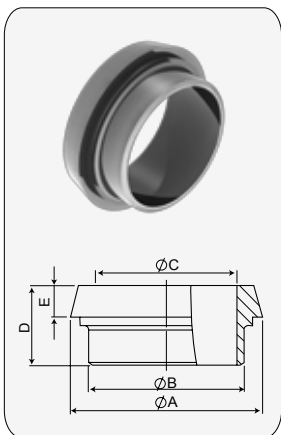

CODE	DN		A	B	C	D	E
PLAS 6L D 12 PLAS 04 D 12	12	316L 304	22.00	15.00	10.00	17.00	6.00
PLAS 6L D 18 PLAS 04 D 18	15	316L 304	28.00	21.00	16.00	17.00	6.00
PLAS 6L D 22 PLAS 04 D 22	20	316L 304	36.00	25.00	20.00	18.00	8.00
PLAS 6L D 28 PLAS 04 D 28	25	316L 304	44.00	31.00	26.00	22.00	10.00
PLAS 6L D 34 PLAS 04 D 34	32	316L 304	50.00	37.00	32.00	25.00	10.00
PLAS 6L D 40 PLAS 04 D 40	40	316L 304	56.00	43.00	38.00	26.00	10.00
PLAS 6L D 52 PLAS 04 D 52	50	316L 304	68.00	55.00	50.00	28.00	11.00
PLAS 6L D 70 PLAS 04 D 70	65	316L 304	86.00	72.00	66.00	32.00	12.00
PLAS 6L D 85 PLAS 04 D 85	80	316L 304	100.00	87.00	81.00	37.00	12.00
PLAS 6L D 1016 PLAS 04 D 1016	100	316L 304	121.00	104.00	99.00	44.00	15.00
PLAS 6L D 104 PLAS 04 D 104	100	316L 304	121.00	106.00	100.00	44.00	15.00
PLAS 6L D 125 PLAS 04 D 125	125	316L 304	150.00	132.00	125.00	34.00	17.00
PLAS 6L D 154 PLAS 04 D 154	150	316L 304	176.00	157.00	150.00	37.00	18.00

Pièce filetée à souder DIN 11850-2

Ferrúla roscada a soldar DIN 11850-2

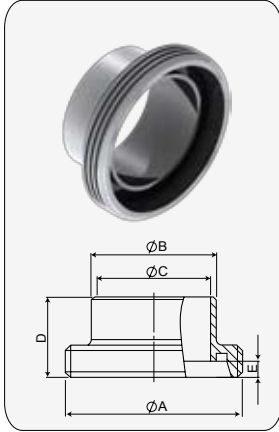

Welding male DIN 11850-2

Штуцер резьбовой DIN 11850-2

CODE	DN		A	B	C	D	E
PFAS 6L D 19	15	316L	RD34 x 1/8"	19.00	16.00	21.00	4.00
PFAS 04 D 19		304					
PFAS 6L D 23	20	316L	RD44 x 1/6"	23.00	20.00	21.00	4.00
PFAS 04 D 23		304					
PFAS 6L D 29	25	316L	RD52 x 1/6"	29.00	26.00	24.00	6.00
PFAS 04 D 29		304					
PFAS 6L D 35	32	316L	RD58 x 1/6"	35.00	32.00	29.00	7.00
PFAS 04 D 35		304					
PFAS 6L D 41	40	316L	RD65 x 1/6"	41.00	48.00	32.00	7.00
PFAS 04 D 41		304					
PFAS 6L D 53	50	316L	RD78 x 1/6"	53.00	50.00	33.00	7.00
PFAS 04 D 53		304					

Pièce lisse à souder DIN 11850-2

Ferrúla lisa a soldar DIN 11850-2

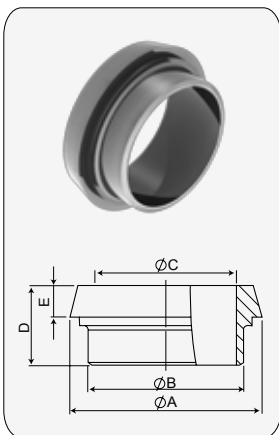

Welding liner DIN 11850-2

Штуцер конический DIN 11850-2

CODE	DN		A	B	C	D	E
PLAS 6L D 19	15	316L	22.00	19.00	16.00	17.00	6.00
PLAS 04 D 19		304					
PLAS 6L D 23	20	316L	28.00	23.00	20.00	17.00	6.00
PLAS 04 D 23		304					
PLAS 6L D 29	25	316L	36.00	29.00	26.00	18.00	8.00
PLAS 04 D 29		304					
PLAS 6L D 35	32	316L	44.00	35.00	32.00	22.00	10.00
PLAS 04 D 35		304					
PLAS 6L D 41	40	316L	50.00	41.00	48.00	25.00	10.00
PLAS 04 D 41		304					
PLAS 6L D 53	50	316L	56.00	53.00	50.00	26.00	10.00
PLAS 04 D 53		304					

Ecrou 4 crans

Tuerca con 4 ranuras

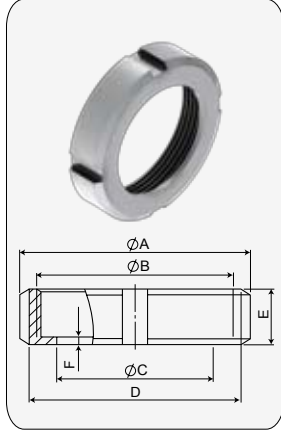

Nut with 4 slots

Гайка накидная

CODE	DN		A	B	C	D	E	F
E 04 D 12	12	304	38.00	RD28 x 1/8"	19.00	33.00	18.00	3.00
E 04 D 18	15	304	44.00	RD34 x 1/8"	25.00	38.00	18.00	3.00
E 04 D 22	20	304	54.00	RD44 x 1/6"	31.00	48.00	20.00	3.00
E 04 D 28	25	304	63.00	RD52 x 1/6"	36.00	56.00	21.00	3.00
E 04 D 34	32	304	70.00	RD58 x 1/6"	42.00	62.00	21.00	3.00
E 04 D 40	40	304	78.00	RD65 x 1/6"	49.00	70.00	21.00	3.00
E 04 D 52	50	304	92.00	RD78 x 1/6"	62.00	84.00	22.00	3.00
E 04 D 70	65	304	112.00	RD95 x 1/6"	80.00	102.00	25.00	4.00
E 04 D 85	80	304	127.00	RD110 x 1/4"	94.00	117.00	29.00	4.00
E 04 D 1016 104	100	304	148.00	RD130 x 1/4"	115.00	138.00	31.00	5.00
E 04 D 1016 104	100	304	148.00	RD130 x 1/4"	115.00	138.00	31.00	5.00
E 04 D 125	125	304	178.00	RD160 x 1/4"	138.00	168.00	35.00	5.00
E 04 D 154	150	304	210.00	RD190 x 1/4"	164.00	200.00	41.00	6.00

Raccord complet DIN à dudgeonner (joint BUNA)

Unión completa DIN a mandrinar (junta BUNA)

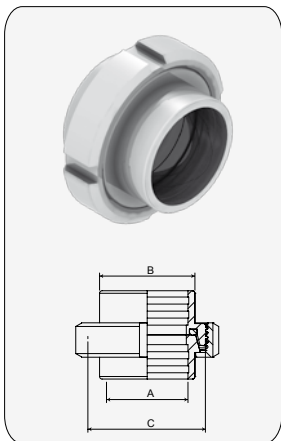

Complete DIN expanding union (BUNA seal)

Соединение резьбовое под развальцовку (уплотнение BUNA)

CODE	DN		A	B	C
RAD 04 D JBU 18	15	304	18.20	24.00	RD34 x 1/8"
RAD 04 D JBU 22	20	304	22.20	30.00	RD44 x 1/6"
RAD 04 D JBU 28	25	304	28.20	35.00	RD52 x 1/6"
RAD 04 D JBU 34	32	304	34.20	41.00	RD58 x 1/6"
RAD 04 D JBU 40	40	304	40.20	48.00	RD65 x 1/6"
RAD 04 D JBU 52	50	304	52.20	61.00	RD78 x 1/6"
RAD 04 D JBU 70	65	304	70.20	79.00	RD95 x 1/6"
RAD 04 D JBU 85	80	304	85.20	93.00	RD110 x 1/4"
RAD 04 D JBU 1016	100	304	101.80	112.00	RD130 x 1/4"
RAD 04 D JBU 104	100	304	104.20	114.00	RD130 x 1/4"

Pièce fileté à dudgeonner

Ferrúla roscada a mandrinar

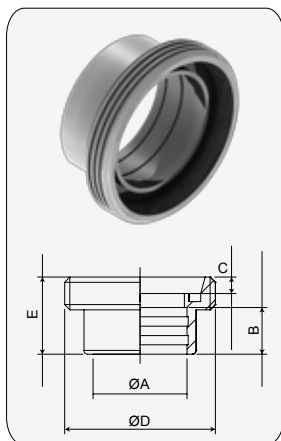

Expanding male

Штуцер резьбовой под развальцовку

CODE	DN		A	B	C	D	E
PFAD 04 D 12	12	304	12.20	12.00	4.00	RD28 x 1/8"	21.00
PFAD 04 D 18	15	304	18.20	12.00	4.00	RD34 x 1/8"	21.00
PFAD 04 D 22	20	304	22.20	12.00	6.00	RD44 x 1/6"	24.00
PFAD 04 D 28	25	304	28.20	15.00	7.00	RD52 x 1/6"	29.00
PFAD 04 D 34	32	304	34.20	18.00	7.00	RD58 x 1/6"	32.00
PFAD 04 D 40	40	304	40.20	20.00	7.00	RD65 x 1/6"	33.00
PFAD 04 D 52	50	304	52.20	22.00	7.00	RD78 x 1/6"	35.00
PFAD 04 D 70	65	304	70.30	25.00	8.00	RD95 x 1/6"	40.00
PFAD 04 D 85	80	304	85.30	28.00	8.00	RD110 x 1/4"	45.00
PFAD 04 D 1016	100	304	101.90	35.00	10.00	RD130 x 1/4"	54.00
PFAD 04 D 104	100	304	104.30	35.00	10.00	RD130 x 1/4"	54.00

Pièce lisse à dudgeonner

Ferrúla lisa a mandrinar

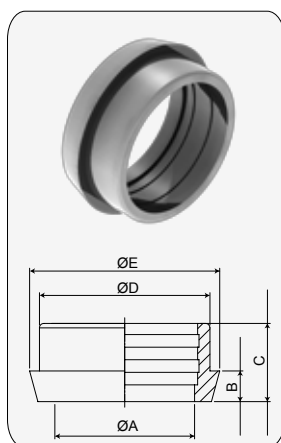

Expanding liner

Штуцер конический под развальцовку

CODE	DN		A	B	C	D	E
PLAD 04 D 12	12	304	12.20	6.00	17.00	18.00	22.00
PLAD 04 D 18	15	304	18.20	6.00	17.00	24.00	28.00
PLAD 04 D 22	20	304	22.20	8.00	18.00	30.00	36.00
PLAD 04 D 28	25	304	28.20	10.00	22.00	35.00	44.00
PLAD 04 D 34	32	304	34.20	10.00	25.00	41.00	50.00
PLAD 04 D 40	40	304	40.20	10.00	26.00	48.00	56.00
PLAD 04 D 52	50	304	52.20	11.00	28.00	61.00	68.00
PLAD 04 D 70	65	304	70.20	12.00	32.00	79.00	86.00
PLAD 04 D 85	80	304	85.20	12.00	37.00	93.00	100.00
PLAD 04 D 1016	100	304	101.80	15.00	44.00	112.00	121.00
PLAD 04 D 104	100	304	104.20	15.00	44.00	114.00	121.00

Joint pour raccord

Junta para unión

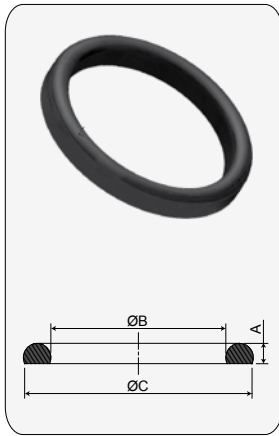

Seal ring for union

Уплотнение для соединения

CODE	DN		A	B	C
JR BU D 12 JR VI D 12	12	BUNA VITON	4.00	12.00	20.00
JR BU D 18 JR VI D 18	15	BUNA VITON	4.00	18.00	26.00
JR BU D 22 JR VI D 22	20	BUNA VITON	4.00	23.00	33.00
JR BU D 28 JR VI D 28	25	BUNA VITON	5.00	30.00	40.00
JR BU D 34 JR VI D 34	32	BUNA VITON	5.00	36.00	46.00
JR BU D 40 JR VI D 40	40	BUNA VITON	5.00	42.00	52.00
JR BU D 52 JR VI D 52	50	BUNA VITON	5.00	54.00	64.00
JR BU D 70 JR VI D 70	65	BUNA VITON	5.00	71.00	81.00
JR BU D 85 JR VI D 85	80	BUNA VITON	5.00	85.00	95.00
JR BU D 1016 JR VI D 1016	100	BUNA VITON	6.00	104.00	114.00
JR BU D 125 JR VI D 125	125	BUNA VITON	7.00	130.00	142.00
JR BU D 154 JR VI D 154	150	BUNA VITON	7.00	155.00	167.00

Fond d'écrou inox

Casquillo ciego inox

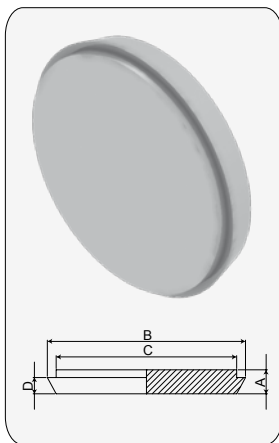

Stainless steel blank

Заглушка стальная

CODE	DN		A	B	C	E
FE 04 D 12	12	304	9.00	22.00	18.00	6.00
FE 04 D 18	15	304	9.00	28.00	24.00	6.00
FE 04 D 28	25	304	13.00	44.00	35.00	10.00
FE 04 D 34	32	304	13.00	50.00	41.00	10.00
FE 04 D 40	40	304	13.00	56.00	48.00	10.00
FE 04 D 52	50	304	14.00	68.00	61.00	11.00
FE 04 D 70	65	304	16.00	86.00	79.00	12.00
FE 04 D 85	80	304	16.00	100.00	93.00	12.00
FE 04 D 1016	100	304	20.00	121.00	114.00	15.00
FE 04 D 125	125	304	22.00	150.00	137.00	17.00
FE 04 D 154	150	304	24.00	176.00	163.00	18.00

Ecrou bouchon inox
Tuerca ciega inox

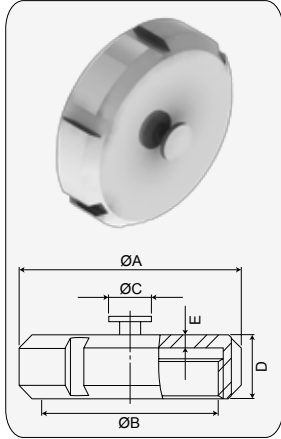

Stainless steel blank nut

Гайка заглушка из нержавеющей стали

CODE	DN		A	B	C	D	E
EBC 04 D 22	20	304	54.00	RD44 x 1/6"	16.00	20.00	3.00
EBC 04 D 28	25	304	63.00	RD52 x 1/6"	16.00	21.00	3.00
EBC 04 D 34	32	304	70.00	RD58 x 1/6"	16.00	21.00	3.00
EBC 04 D 40	40	304	78.00	RD65 x 1/6"	16.00	21.00	3.00
EBC 04 D 52	50	304	92.00	RD78 x 1/6"	16.00	22.00	3.00
EBC 04 D 70	65	304	112.00	RD95 x 1/6"	16.00	25.00	4.00
EBC 04 D 85	80	304	127.00	RD110 x 1/4"	16.00	30.00	5.00
EBC 04 D 1016	100	304	148.00	RD130 x 1/4"	16.00	31.00	5.00
EBC 04 D 125	125	304	178.00	RD160 x 1/4"	16.00	35.00	6.00

Ecrou bouchon plastique
Tuerca ciega plástica

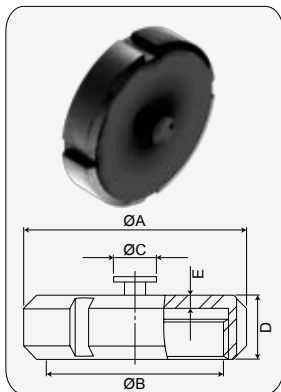

Plastic blank nut

Гайка заглушка пластмассовая

CODE	DN		A	B	C	D	E
EBP PL D 22	20	PLAST.	54.00	RD44 x 1/6"	16.00	20.00	3.00
EBP PL D 28	25	PLAST.	63.00	RD52 x 1/6"	16.00	21.00	3.00
EBP PL D 34	32	PLAST.	70.00	RD58 x 1/6"	16.00	21.00	3.00
EBP PL D 40	40	PLAST.	78.00	RD65 x 1/6"	16.00	21.00	3.00
EBP PL D 52	50	PLAST.	92.00	RD78 x 1/6"	16.00	22.00	3.00
EBP PL D 70	65	PLAST.	112.00	RD95 x 1/6"	16.00	25.00	4.00
EBP PL D 85	80	PLAST.	127.00	RD110 x 1/4"	16.00	30.00	5.00
EBP PL D 1016	100	PLAST.	148.00	RD130 x 1/4"	16.00	31.00	5.00
EBP PL D 125	125	PLAST.	178.00	RD160 x 1/4"	16.00	35.00	6.00

Joint d'écrou bouchon (BUNA)
Junta para tuerca ciega (Buna)

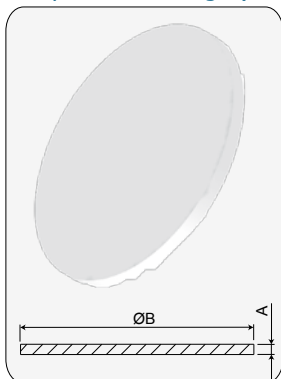

Buna seal for blank nut

Уплотнение (BUNA) для гайки заглушки

CODE	DN		A	B
JEB BU D 28	25	BUNA	3.00	52.00
JEB BU D 34	32	BUNA	3.00	58.00
JEB BU D 40	40	BUNA	3.00	65.00
JEB BU D 52	52	BUNA	3.00	78.00
JEB BU D 70	65	BUNA	3.00	95.00
JEB BU D 85	80	BUNA	3.00	110.00
JEB BU D 1016	100	BUNA	3.00	125.00

Ferrule (longueur = 21.5mm)

Ferrúla (longitud = 21.5mm)

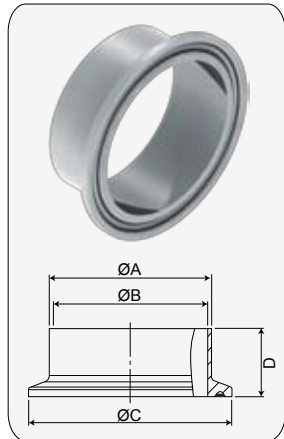

Ferrule (length=21.5mm)

Патрубок зажимного соединения (длина = 21,5)

CODE	DN		A	B	C	D
FC 6L D 28	25	316L	28.00	25.00	50.50	21.50
FC 6L D 34	32	316L	34.00	31.00	50.50	21.50
FC 6L D 40	40	316L	40.00	37.00	50.50	21.50
FC 6L D 52	50	316L	52.00	49.00	64.00	21.50
FC 6L D 70	65	316L	70.00	66.00	91.00	21.50
FC 6L D 85	80	316L	85.00	81.00	106.00	21.50
FC 6L D 104	100	316L	104.00	100.00	119.00	21.50

Joint de raccord CLAMP

Junta para unión CLAMP

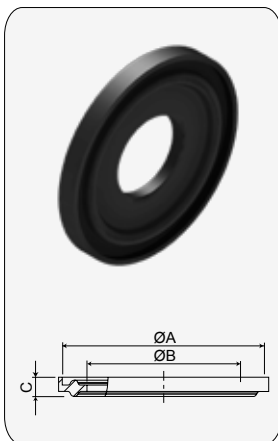

Lip seal for ferrule

Уплотнение для зажимного соединения

CODE	DN		A	B	C
JCS EP D 28	25	EPDM	50.50	26.20	5.00
JCS VI D 28		FKM			
JCS SI D 28		SILICONE			
JCS TE D 28		PTFE			
JC JE D 28		PTFE/EPDM			
JCS EP D 34	32	EPDM	50.50	32.20	5.00
JCS VI D 34		FKM			
JCS SI D 34		SILICONE			
JCS TE D 34		PTFE			
JC JE D 34		PTFE/EPDM			
JCS EP D 40	40	EPDM	50.50	38.20	5.00
JCS VI D 40		FKM			
JCS SI D 40		SILICONE			
JCS TE D 40		PTFE			
JC JE D 40		PTFE/EPDM			
JCS EP D 52	50	EPDM	64.00	50.20	5.00
JCS VI D 52		FKM			
JCS SI D 52		SILICONE			
JCS TE D 52		PTFE			
JC JE D 52		PTFE/EPDM			
JCS EP D 70	65	EPDM	77.50	66.20	5.00
JCS VI D 70		FKM			
JCS SI D 70		SILICONE			
JCS TE D 70		PTFE			
JC JE D 70		PTFE/EPDM			
JCS EP D 85	80	EPDM	91.00	81.20	5.00
JCS VI D 85		FKM			
JCS SI D 85		SILICONE			
JCS TE D 85		PTFE			
JC JE D 85		PTFE/EPDM			
JCS EP D 104	100	EPDM	119.00	100.20	5.00
JCS VI D 104		FKM			
JCS SI D 104		SILICONE			
JCS TE D 104		PTFE			
JC JE D 104		PTFE/EPDM			

Bouchon CLAMP

Tapón CLAMP

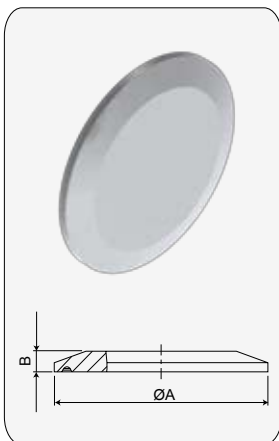

CLAMP blank

Заглушка зажимного соединения

CODE	DN		A	B
BC 6L D 28	25	316L	50.50	5.00
BC 6L S 34	32	316L	50.50	5.00
BC 6L D 40	40	316L	50.50	5.00
BC 6L D 52	50	316L	64.00	5.00
BC 6L D 70	65	316L	91.00	6.00
BC 6L D 85	80	316L	106.00	6.00
BC 6L D 104	100	316L	119.00	6.00

Collier CLAMP simple agrafe

Abrazadera CLAMP simple grapa

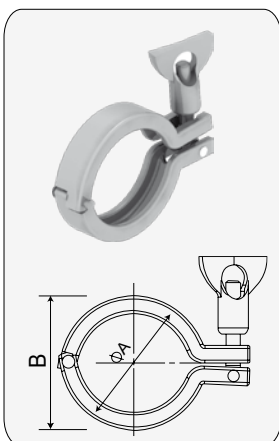

Heavy CLAMP (Single Pin)

Обойма литая (простая сцепка)

CODE	DN		A	B
CCTM 04 S 2538	25/32/40	304	50.50	65.20
CCTM 04 S 51	50	304	64.00	78.70
CCTM 04 S 76	65	304	91.00	105.70
CC 04 W 88.9	80	304	106.00	127.00
CCTM 04 S 104	100	304	119.00	133.70

Collier CLAMP double agrafe

Abrazadera CLAMP doble grapa

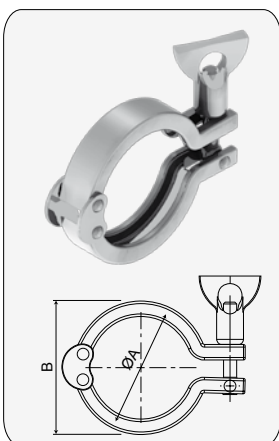

Heavy CLAMP (Double Pin)

Обойма литая (двойная сцепка)

CODE	DN		A	B
CCS 04 S 2538	25/32/40	304	50.50	65.20
CCS 04 S 51	50	304	64.00	78.70
CCS 04 S 76	65	304	91.00	105.70
CCS 04 S 104	100	304	119.00	133.70

Coudes alimentaires 1.5D à 90° sans partie droite

Codos alimenticios 1.5D 90° sin recto

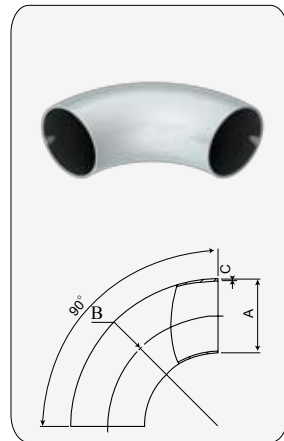

Sanitary bends 1.5D 90° without straight end

Отвод пищевой 1.5 D 90°

CODE	DN		A	B	C
COAL 6L PE S D 90 15 22	20	316L	22.00	40.00	1.50
COAL 04 PE S D 90 15 22		304			
COAL 6L PE S D 90 15 28	25	316L	28.00	50.00	1.50
COAL 04 PE S D 90 15 28		304			
COAL 6L PE S D 90 15 34	32	316L	34.00	55.00	1.50
COAL 04 PE S D 90 15 34		304			
COAL 6L PE S D 90 15 40	40	316L	40.00	60.00	1.50
COAL 04 PE S D 90 15 40		304			
COAL 6L PE S D 90 15 52	50	316L	52.00	70.00	1.50
COAL 04 PE S D 90 15 52		304			
COAL 6L PE S D 90 15 70	65	316L	70.00	80.00	2.00
COAL 04 PE S D 90 15 70		304			
COAL 6L PE S D 90 15 85	80	316L	85.00	90.00	2.00
COAL 04 PE S D 90 15 85		304			
COAL 6L PE S D 90 15 104	100	316L	104.00	100.00	2.00
COAL 04 PE S D 90 15 104		304			
COAL 6L PE S D 90 15 125	125	316L	129.00	187.50	2.00
COAL 04 PE S D 90 15 125		304			
COAL 6L PE S D 90 15 150	150	316L	154.00	225.00	2.00
COAL 04 PE S D 90 15 150		304			

Coudes alimentaires 1.5D à 90° avec partie droite

Codos alimenticios 1.5D 90° con recto

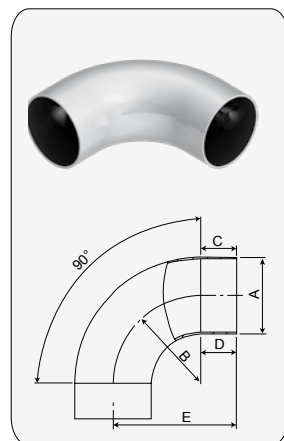

Sanitary bends 1.5D 90° with straight end

Отвод пищевой 1.5 D 90° с прямыми концами

CODE	DN		A	B	C	D	E
COAL 6L PE A D 90 15 18	15	316L	18.00	35.00	1.50	12.00	47.00
COAL 04 PE A D 90 15 18		304					
COAL 6L PE A D 90 15 22	20	316L	22.00	40.00	1.50	12.00	52.00
COAL 04 PE A D 90 15 22		304					
COAL 6L PE A D 90 15 28	25	316L	28.00	50.00	1.50	20.00	70.00
COAL 04 PE A D 90 15 28		304					
COAL 6L PE A D 90 15 34	32	316L	34.00	52.00	1.50	26.00	78.00
COAL 04 PE A D 90 15 34		304					
COAL 6L PE A D 90 15 40	40	316L	40.00	60.00	1.50	30.00	90.00
COAL 04 PE A D 90 15 40		304					
COAL 6L PE A D 90 15 52	50	316L	52.00	72.00	2.00	28.00	100.00
COAL 04 PE A D 90 15 52		304					
COAL 6L PE A D 90 15 70	65	316L	70.00	85.00	2.00	25.00	110.00
COAL 04 PE A D 90 15 70		304					
COAL 6L PE A D 90 15 85	80	316L	85.00	93.00	2.00	37.00	130.00
COAL 04 PE A D 90 15 85		304					
COAL 6L PE A D 90 15 104	100	316L	104.00	110.00	2.00	40.00	140.00
COAL 04 PE A D 90 15 104		304					

Tés sans partie droite à souder

Té sin recto a soldar

Tees without straight end

Тройник короткий

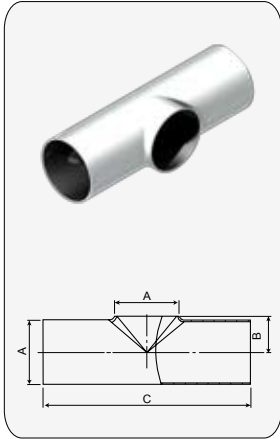

CODE	DN		A	B	C
TEAS 6L PE S D 22	20	316L	22.00	13.50	94.00
TEAS 04 PE S D 22		304			
TEAS 6L PE S D 28	25	316L	28.00	16.50	100.00
TEAS 04 PE S D 28		304			
TEAS 6L PE S D 34	32	316L	34.00	19.00	110.00
TEAS 04 PE S D 34		304			
TEAS 6L PE S D 40	40	316L	40.00	22.00	120.00
TEAS 04 PE S D 40		304			
TEAS 6L PE S D 52	50	316L	52.00	29.50	140.00
TEAS 04 PE S D 52		304			
TEAS 6L PE S D 70	65	316L	70.00	40.00	160.00
TEAS 04 PE S D 70		304			
TEAS 6L PE S D 85	80	316L	85.00	48.50	180.00
TEAS 04 PE S D 85		304			
TEAS 6L PE S D 104	100	316L	104.00	55.00	200.00
TEAS 04 PE S D 104		304			

Tés avec partie droite à souder

Té con recto a soldar

Tees with straight end

Тройник длинный

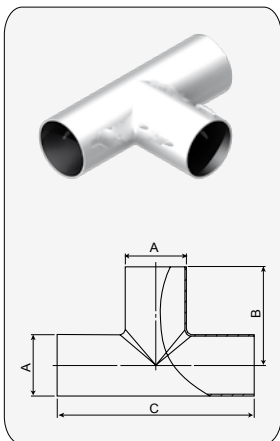

CODE	DN	SS	A	B	C
TEAD 6L PE A D 22	20	316L	22.00	47.00	94.00
TEAD 04 PE A D 22		304			
TEAD 6L PE A D 28	25	316L	28.00	50.00	100.00
TEAD 04 PE A D 28		304			
TEAD 6L PE A D 34	32	316L	34.00	55.00	110.00
TEAD 04 PE A D 34		304			
TEAD 6L PE A D 40	40	316L	40.00	60.00	120.00
TEAD 04 PE A D 40		304			
TEAD 6L PE A D 52	50	316L	52.00	70.00	140.00
TEAD 04 PE A D 52		304			
TEAD 6L PE A D 70	65	316L	70.00	80.00	160.00
TEAD 04 PE A D 70		304			
TEAD 6L PE A D 85	80	316L	85.00	90.00	180.00
TEAD 04 PE A D 85		304			
TEAD 6L PE A D 1016	100	316L	101.60	100.00	200.00
TEAD 04 PE A D 1016		304			
TEAD 6L PE A D 104	100	316L	104.00	100.00	200.00
TEAD 04 PE A D 104		304			

Réductions concentriques sans partie droite

Reducción concéntrica sin recto

Concentric reducer without straight end

Переход концентрический

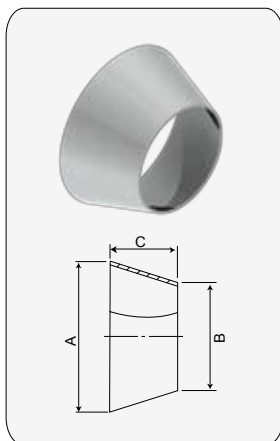

CODE	DN		A	B	C
RECA 04 PE SD 34 28	32-25	304	34.00	28.00	67.00
RECA 04 PE SD 40 28	40-25	304	40.00	28.00	67.00
RECA 04 PE SD 40 34	40-32	304	40.00	34.00	67.00
RECA 04 PE SD 52 28	50-25	304	52.00	28.00	67.00
RECA 04 PE SD 52 34	50-32	304	52.00	34.00	67.00
RECA 04 PE SD 52 40	50-40	304	52.00	40.00	67.00
RECA 04 PE SD 70 40	65-40	304	70.00	40.00	67.00
RECA 04 PE SD 70 52	65-50	304	70.00	52.00	67.00
RECA 04 PE SD 85 52	80-50	304	85.00	52.00	67.00
RECA 04 PE SD 85 70	80-65	304	85.00	70.00	67.00
RECA 04 PE SD 104 52	100-50	304	104.00	52.00	67.00
RECA 04 PE SD 104 70	100-65	304	104.00	70.00	67.00
RECA 04 PE SD 104 85	100-80	304	104.00	85.00	67.00

Collier hexagonal support tube sans tige

Soporte hexagonal sin base para tubo

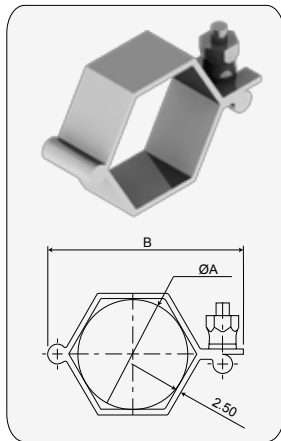

CODE	DN		A	B
CIDS 04 D 28	25	304	28.00	64.00
CIDS 04 D 34	32	304	34.00	64.00
CIDS 04 D 40	40	304	40.00	78.00
CIDS 04 D 52	50	304	52.00	90.00
CIDS 04 D 70	65	304	70.00	111.00
CIDS 04 D 85	80	304	85.00	125.00
CIDS 04 D 104	100	304	104.00	146.00

Hex pipe hanger without base

Хомут шестиугольный для труб

Collier hexagonal support tube à tige

Soporte hexagonal con base para tubo

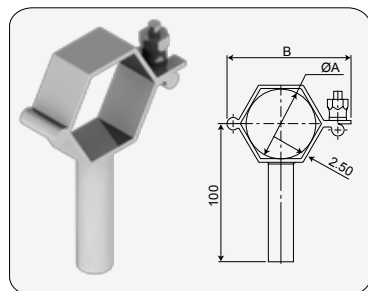

CODE	DN		A	B
CISB 04 D 28	25	304	28.00	64.00
CISB 04 D 34	32	304	34.00	64.00
CISB 04 D 40	40	304	40.00	78.00
CISB 04 D 52	50	304	52.00	90.00
CISB 04 D 70	65	304	70.00	111.00
CISB 04 D 85	80	304	85.00	125.00
CISB 04 D 104	100	304	104.00	146.00

Hex pipe hanger with base

Хомут шестиугольный для труб с надставкой

Collier rond support tube à tige pleine

Soporte redondo con base llena para tubo

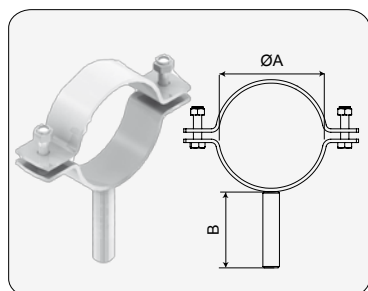

CODE	DN		A	B
CSTR 04 D 28	25	304	28.00	55.00
CSTR 04 D 34	32	304	34.00	55.00
CSTR 04 D 40	40	304	40.00	55.00
CSTR 04 D 52	50	304	52.00	55.00
CSTR 04 D 70	65	304	70.00	55.00
CSTR 04 D 85	80	304	85.00	55.00
CSTR 04 D 104	100	304	104.00	55.00

Round pipe hanger with solid base

Хомут круглый для труб с надставкой

Tubes sans traitement thermique

Tubo no tratado

Sanitary pipe without heat treatment

Пищевая труба



CODE	DN		DIAMETRE
TUAD 6L PE D 18 15	15	316L	18 x 1.50
TUAD 04 PE D 18 15		304	
TUAD 6L PE D 22 15	20	316L	22 x 1.50
TUAD 04 PE D 22 15		304	
TUAD 6L PE D 28 15	25	316L	28 x 1.50
TUAD 04 PE D 28 15		304	
TUAD 6L PE D 34 15	32	316L	34 x 1.50
TUAD 04 PE D 34 15		304	
TUAD 6L PE D 40 15	40	316L	40 x 1.50
TUAD 04 PE D 40 15		304	
TUAD 6L PE D 52 15	50	316L	52 x 1.50
TUAD 04 PE D 52 15		304	
TUAD 6L PE D 70 2	65	316L	70 x 2.00
TUAD 04 PE D 70 2		304	
TUAD 6L PE D 85 2	80	316L	85 x 2.00
TUAD 04 PE D 85 2		304	
TUAD 6L PE D 104 2	100	316L	104 x 2.00
TUAD 04 PE D 104 2		304	
TUAD 6L PE D 129 2	125	316L	129 x 2.00
TUAD 04 PE D 129 2		304	
TUAD 6L PE D 154 2	150	316L	154 x 2.00
TUAD 04 PE D 154 2		304	

Tube avec traitement thermique sur demande

Tubo tratado a petición

Sanitary pipe with heat treatment on request

Пищевая труба термообработанная